

2023

 **Comfortex**
WINDOW FASHIONS

Distributed by:

 **MDS** Midwest
WINDOW FASHIONS Designer
Supply

1-888-523-2611



COLOR LUXTM

COLOR LUX[®] SHEER SHADINGS

Manufacturer's Price List and Reference Guide

Effective April 17, 2023



Detailed Table of Contents



Hardware



Photos



Price Grids



Videos



Product Specifications



Installation



General Information



Web



 Requires you to leave document

Color Lux Sheer Shadings Price List - Effective 04.17.2023

Version 1

Original Price List Effective April 17, 2023

Uploaded 03/17/2023



Hardware Options



Size Standards



**Hardware Options
Pricing**



Bluetooth®

COLOR LUX SIMPLICITY BLUETOOTH MOTORS QUIETUDE™ TECHNOLOGY







Color Lux Simplicity Bluetooth motors now feature our exclusive Quietude™ technology. Our Quietude™ technology significantly reduces motor running noise, and delivers both performance and a user-friendly customer experience.

Color lux Simplicity Bluetooth motors, with Radio-Frequency, Bluetooth and SmartHub control options, are now are one of the quietest and most completely versatile offerings in the industry.

Quietude™ technology enables shades to operate at the same speed, so all shades perform consistently. The operating speeds can also be adjusted using our Color Lux Mobile app.

Color Lux Simplicity Bluetooth motors now also communicate daily with other Quietude™ motors in the proximity in order to synchronize schedules, as set in the Color Lux Mobile app.

Color Lux® Sheer Shadings
HARDWARE OPTIONS

	Key Features	Color Options	Head Rail Size (Depth x Height)	Shade Size Available	More Information
<p>Cord Loop</p> 	<ul style="list-style-type: none"> • Cord Loop makes operation easy • Smooth & quiet operation • Braided cord loop is used to raise and lower the shading • Bead Cord is optional 	<ul style="list-style-type: none"> • Fabric Wrap is Standard • White • Ivory • Onyx Black • Oil Rubbed Bronze 	Fabric Wrapped: 3¾" x 2¾"	<p>Width: 12" to 120"*</p> <p>Length: 12" to 132"***</p>	Page 9
<p>Retractable Cord</p> 	<ul style="list-style-type: none"> • Single Cord Design • Provides easy one hand operation • Maintains a consistent cord length • Enhances child and pet safety 	<ul style="list-style-type: none"> • White • Black • Bronze 	Fabric Wrapped: 3¾" to 2¾"	<p>Width: 12" to 120"*</p> <p>Length: 12" to 72"</p>	Page 11
<p>Cordless Shading</p> 	<ul style="list-style-type: none"> • Cord Free • Roller catch mechanism in the head rail • Vanes easily adjusted into various positions 	<ul style="list-style-type: none"> • Clear handle • Bottom Rail is fabric wrapped 	Fabric Wrapped: 3¾" to 2¾"	<p>Width: 20" to 84"</p> <p>Length: 18" to 96"</p>	Page 13
<p>12V Non-Rechargeable Simplicity Motorization</p> 	<ul style="list-style-type: none"> • Raise & lower shade with click of a button • Great for large and hard to reach windows • Remote can operate multiple shades • Bluetooth available 	<ul style="list-style-type: none"> • Designer Cassette options • 14 Channel white Remote with timer 	Fabric Wrapped: 3¾" to 2⅞"	<p>Width: 14" to 120"*</p> <p>Length: 12" to 132"***</p>	Page 18
<p>7.4V Rechargeable Simplicity Motorization with Quietude™ Technology</p> 	<ul style="list-style-type: none"> • Features a battery powered motor utilizing a rechargeable integrated battery pack • Raise & lower shading with click of a button • Great for large and hard to reach windows • Remote can operate multiple shades • Bluetooth available 	<ul style="list-style-type: none"> • Designer Cassette options • 14 Channel white Remote with timer 	Fabric Wrapped: 3¾" to 2¾"	<p>Width: 19.25" IM 18.875" OM 19.375" SM to 120"*</p> <p>Length: 12" to 132"***</p>	Page 20
<p>7.4V Rechargeable PowerTouch</p> 	<ul style="list-style-type: none"> • Raise & lower shading with push of a button • Eliminate the need to stand by the shading to operate; just touch and go • Favorite position button • Rechargeable battery with recharge port on pendant 	<ul style="list-style-type: none"> • Wand and pendant available in white or black 	Fabric Wrapped: 3¾" x 2¾"	<p>Width: 18" to 120"</p> <p>Length: 12" to 132"</p>	Page 16

* Maximum width of 120" IB, 119¾" OB

** Light Filtering 132", Room Darkening 122"

Color Lux® Sheer Shadings FABRIC COLLECTIONS

Color Lux Printed Sheer Shadings are available with different fabric collections.

COLLECTION	3" Vanes
Light Filtering	•
Room Darkening	•

Please Note: Room Darkening fabrics are not blackout fabrics. Knitted fabric may experience minor weave variations due to heat, humidity and other room conditions. These variations can result in light bowing, puckering and dimpling of the Shangri-La material. This is considered normal and does not constitute a failure in either workmanship or materials. The possible variations are minor and have been shown through case study not to detract from the beauty of the product.

Color Lux® Sheer Shadings HARDWARE OPTION AVAILABILITY

Use this table to ensure your coordinating options and unique shapes are consistent with your product selections.

CORD LOOP	3" Vanes	Bluetooth
Cord Loop	•	NA
Cord Loop Two-On-One	•	NA
RETRACTABLE CORD		
Retractable Cord	•	NA
Retractable Cord Two-On-One	•	NA
CORDLESS SHADING		
Cordless Shading	•	NA
Cordless Shading Two-On-One	NA	NA
SIMPLICITY MOTORIZATION WITH QUIETUDE™ TECHNOLOGY		
Simplicity Motorization	•	•
Simplicity Motorization Two-On-One	•	•
SIMPLICITY RECHARGEABLE MOTORIZATION WITH QUIETUDE™ TECHNOLOGY		
Simplicity Rechargeable	•	•
Simplicity Rechargeable Two-On-One	•	•
POWERTOCH RECHARGEABLE MOTORIZATION		
PowerTouch Rechargeable	•	NA
PowerTouch Rechargeable Two-On-One	•	NA



Fabric Wrapped is Standard



Metallic Hardware Upgrades



Bottom Rail Partly Opened
(Bottom Rail is always fabric wrapped)



Bottom Rail Closed

Color Lux® Sheer Shadings

SIZE STANDARDS

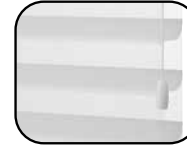

		Cord Loop	Retractable Cord	Cordless Shading
ALL FABRICS	Minimum Width	12"	12"	20"
	Minimum Length	12"	12"	12"

Light Filtering	Price Group	Page		Cord Loop	Retractable Cord	Cordless Shading
3" Vanes	1	Z	Maximum Width & Length	120"* x 132"	120"* x 72"	84" x 96"

Room Darkening	Price Group	Page		Cord Loop	Retractable Cord	Cordless Shading
3" Vanes	2	Z	Maximum Width & Length	120"* x 122"	120"* x 72"	84" x 96"

	Cord Loop	Retractable Cord	Cordless Shading
More Information On Page	Page 9	Page 11	Page 13

* Maximum width of 120" IB, 119¾" OB

Color Lux® Sheer Shadings
SIZE STANDARDS



		Motorization	Motorization	Motorization	Two-On-One
		Bluetooth® 7.4V Rechargeable Simplicity	12V Non-Rechargeable Simplicity	7.4V Rechargeable PowerTouch	
ALL FABRICS	Minimum Width	20.25" IM 19.875" OM 20.375" SM	14"	18"	See Table Below*
	Minimum Length	12"	12"	12"	12"

				Motorization	Motorization	Motorization	Two-On-One
				Bluetooth® 7.4V Rechargeable Simplicity	12V Non-Rechargeable Simplicity	7.4V Rechargeable PowerTouch	
Light Filtering	Price Group	Page	Maximum Width & Length	120"* x 132"	120" x 132"	120"* x 132"	140" x 132"
3" Vanes	1	Z					

				Motorization	Motorization	Motorization	Two-On-One
				Bluetooth® 7.4V Rechargeable Simplicity	12V Non-Rechargeable Simplicity	7.4V Rechargeable PowerTouch	
Room Darkening	Price Group	Page #	Maximum Width & Length	120"* x 122"	12" x 122"	120"* x 122"	140" x 122"
3" Vanes	2	Z					

				Motorization	Motorization	Motorization	Two-On-One
				Bluetooth® 7.4V Rechargeable Simplicity	12V Non-Rechargeable Simplicity	7.4V Rechargeable PowerTouch	
More Information On Page				Page 20	Page 18	Page 16	Page 12

* Maximum width of 120" IB, 119¾" OB

	Minimum Width	Hardware
TWO-ON-ONE HARDWARE+	24"	Cord Loop
	24"	Retractable Cord
	NA	Cordless
	28"	Simplicity Motorization
	38"	Simplicity Rechargeable
	36"	PowerTouch Rechargeable

Color Lux® Sheer Shadings

HARDWARE UPGRADE OPTIONS

LIFT SYSTEM	UPGRADES	ADD
Cord Loop	Bottom Up	Included
Retractable Cord	Bottom Up	\$84
Cordless Shading	Bottom Up	\$84

DESIGNER UPGRADE OPTIONS	UPGRADES	ADD
Add to Any Lift System Upgrade (Chart to the left)	Metallic Hardware	\$113
	Friction Fit Mounting System <i>Page 24 For More Information</i>	\$94
	Scotchgard Stain Protection	\$48

ADDITIONAL OPTIONS	UPGRADES	ADD
Add to Any Upgrade Above	Two-On-One Head Rail	Price as two shadings and add together.
Accessories	3 Foot Expandable Pole - Silver	\$30
	5-10 Foot Expandable Pole - Black	\$54

Shangri-La Sheer Horizontal Shadings **Motorized** Hardware Upgrade Options

MOTORIZED	UPGRADES	ADD	
Simplicity Bluetooth™ with Quietude™ Technology 	Bluetooth Motors work with Remote Control	\$300	For More Information Page 20
	Color Lux Bluetooth Mobile App	FREE	
7.4V Rechargeable PowerTouch Wand System	Rechargeable Integrated Battery Pack	\$100	For More Information Page 16
	Plug-In Charger for Rechargeable Li-Ion	\$30	
7.4V Rechargeable Simplicity Accessories	Plug-In Charger for Rechargeable Li-Ion	\$30	For More Information Page 22
	7.4v Solar Panel Kit (Remote Control only)	\$120	
7.4V EZ Charge Extension Wand	Wall Mount Receiver Kit	\$18	For More Information Page 23
	Extendable Wand	\$32	
12V Non-Rechargeable Simplicity Motorization System	Motor and Alkaline Battery Wand	\$300	For More Information Page 18 and 25
	48" Extension Wire	\$10	
	Single Unit DC Power Supply/Transformer	\$30	
	9 Channel Wall Mount Low Voltage Hardwire Transformer (More info page 25)	\$232	
Simplicity Systems Controllers	NEO Controller	\$280	For More Information Pages 26 & 19
	NEO Application for Mobile Devices	FREE	
	Simplicity 14 Channel White Remote	\$50	

Color Lux Shangri-La Sheer Horizontal Sheer Shading Pricing Examples

Two-On-One Pricing Example:

3" Light Filtering	
42" x 60" Shadings:	\$1070.00 x 2
	\$2140.00
Retractable Cord Upgrade:	\$84.00 x 2
	\$168.00
Total List Price:	\$2308.00

Simplicity Rechargeable Motorization Pricing Example:

3" Light Filtering 42" x 60" Shade:	\$1070.00
Metallic Hardware Option	\$113
Simplicity Rechargeable Surcharge:	\$300.00
Charger for Rechargeable (required):	\$30.00
Simplicity Remote Control:	\$50.00
Total List Price:	\$1563.00



1

3" Vanes - Cord Loop
Light Filtering



2

3" Vanes - Cord Loop
Room Darkening

Color Lux® Sheer Shadings PRICING

3" Light Filtering Vanes

PRICE GROUP 1 Cord Loop

		Width In Inches												
		24	30	36	42	48	54	60	66	72	84	96	108	120
Length In Inches	36	570	639	715	781	855	929	998	1070	1252	1405	1551	1883	2215
	42	601	676	750	836	911	996	1070	1147	1338	1504	1657	2020	2383
	48	636	716	803	884	969	1055	1145	1237	1427	1598	1768	2164	2557
	54	662	749	845	935	1032	1121	1222	1323	1511	1692	1892	2369	2843
	60	693	793	888	987	1083	1194	1297	1406	1591	1800	2017	2531	3045
	66	722	829	934	1039	1147	1263	1386	1497	1679	1914	2145	2691	3236
	72	750	867	981	1093	1213	1338	1459	1584	1768	2020	2270	2867	3460
	78	774	898	1015	1140	1268	1397	1525	1658	1854	2124	2383	3012	3637
	84	807	934	1057	1199	1332	1469	1611	1750	1948	2238	2513	3162	3817
	90	841	969	1106	1250	1397	1549	1687	1836	2043	2343	2637	3337	4036
	96	872	1011	1150	1307	1459	1612	1764	1919	2137	2452	2762	3505	4245
	102	999	1154	1314	1486	1641	1790	2002	2195	2347	2670	2979	3602	4335
	108	1051	1215	1386	1564	1723	1890	2104	2313	2474	2806	3135	3792	4447
	114	1113	1288	1467	1657	1836	2007	2231	2451	2623	2979	3323	4022	4721
120	1199	1380	1576	1776	1958	2145	2384	2623	2806	3188	3558	4304	5047	
126	1276	1469	1678	1890	2089	2286	2542	2801	2992	3401	3793	4588	5386	
132	1359	1565	1786	2013	2224	2439	2710	2984	3190	3622	4041	4890	5738	

3" Room Darkening Vanes

PRICE GROUP 2 Cord Loop

		Width In Inches												
		24	30	36	42	48	54	60	66	72	84	96	108	120
Length In Inches	36	627	704	786	859	940	1023	1097	1178	1378	1546	1707	2071	2436
	42	660	744	827	919	1004	1096	1178	1262	1472	1653	1825	2223	2622
	48	699	788	884	972	1066	1161	1260	1359	1570	1757	1945	2380	2813
	54	729	826	928	1030	1136	1234	1345	1457	1662	1861	2081	2606	3127
	60	761	874	976	1084	1192	1314	1427	1546	1750	1980	2218	2783	3349
	66	796	915	1028	1143	1262	1391	1523	1647	1846	2105	2360	2960	3560
	72	827	954	1078	1201	1333	1472	1605	1744	1945	2223	2497	3154	3806
	78	851	988	1116	1254	1395	1538	1678	1825	2039	2337	2622	3312	4001
	84	887	1028	1164	1320	1464	1617	1774	1925	2144	2462	2765	3478	4198
	90	925	1066	1216	1376	1536	1705	1866	2020	2247	2579	2901	3671	4440
	96	959	1112	1266	1437	1605	1775	1940	2110	2349	2698	3039	3856	4669
	102	1099	1271	1445	1634	1806	1969	2200	2417	2582	2938	3276	3961	4769
	108	1156	1335	1523	1719	1896	2077	2313	2544	2722	3086	3448	4172	4892
	114	1225	1418	1614	1825	2020	2208	2455	2697	2886	3276	3656	4424	5193
120	1320	1516	1732	1951	2154	2360	2622	2886	3088	3506	3914	4735	5552	
122	1403	1617	1844	2079	2298	2514	2797	3081	3292	3741	4173	5047	5925	

LIFT SYSTEM	UPGRADES	ADD
Cord Loop	Bottom Up	Included
Retractable Cord	Bottom Up	\$84
Cordless Shading	Bottom Up	\$84

DESIGNER UPGRADE OPTIONS	UPGRADES	ADD
Add to Any Lift System Upgrade (Chart to the left)	Metallic Hardware	\$113
	Friction Fit Mounting System <i>Page 24 For More Information</i>	\$94
	Scotchgard Stain Protection	\$48

ADDITIONAL OPTIONS	UPGRADES	ADD
Add to Any Upgrade Above	Two-On-One Head Rail	Price as two shadings and add together.
Accessories	3 Foot Expandable Pole - Silver	\$30
	5-10 Foot Expandable Pole - Black	\$54

MOTORIZATION	MORE INFO
For motorization surcharges and options refer to page 5.	Pg 5

Shadings wider than 96": Shadings over 96" in width may require additional fabrication and delivery time.



**Cord Loop
Hardware**



**12V Non-Rechargeable
Simplicity**



**Retractable Cord
Hardware**



**7.4V Rechargeable
Simplicity**



**Two-On-One
Hardware**



**Friction Fit
Mounting System**



**Cordless
Hardware**



**12V Simplicity
Low Voltage Hardwiring**



**Simplicity Bluetooth
Motorization**



**Simplicity Smart
Controller**



**7.4V Rechargeable
Powertouch**

Color Lux® Sheer Shadings
CORD LOOP SHADING HARDWARE SYSTEM | DESIGNER CASSETTE HEAD RAIL



Fabric Wrapped

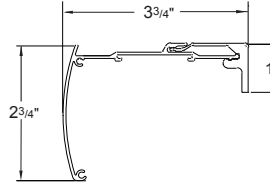

Fabric Wrapped Designer Cassette Head Rail

- Depth of rail and bracket: 3 3/4"
- Height of rail: 2 3/4"
- Height of bracket: 1"



Bottom Rail Partly Opened



Bottom Rail Closed

(Bottom Rail is always fabric wrapped)

Hardware Features	
Standard Designer Cassette	Fabric Wrapped Designer Cassette is standard. Head rail endcap is fabric covered
Bottom Rail Color	Bottom rail is fabric wrapped with white end caps.
Head Rail Upgrades <i>(Bottom rail is always fabric wrapped)</i>	
Designer Metallic Upgrade (Smooth Face)	<ul style="list-style-type: none"> • Oil Rubbed Bronze • Onyx Black
Mounting Dimensions	
Designer Cassette Head Rail	
Minimum Shallow Mount	1"
Minimum Flush Inside Mount (including brackets)	3 3/4"
Minimum Outside Mount	1"
Minimum Side Mount	1 1/4"
Width Side Mount	48" Max width side mount
Finished Dimensions	
Inside Mount	
	<ul style="list-style-type: none"> • Fabric will measure ordered width less: 1" • Head rail* will measure ordered width less: 3/16"
Side (End) Mount	
	<ul style="list-style-type: none"> • Fabric will measure ordered width less: 1 1/2" • Head rail* will measure ordered width less: 1 1/16"
Outside Mount	
	<ul style="list-style-type: none"> • Fabric will measure ordered width less: 5/8" • Head rail* will measure ordered width plus: 3/16"
Exact (End Cap to End Cap) Mount	
	<ul style="list-style-type: none"> • Fabric will measure ordered width less: 1 3/16" • Head rail* will measure ordered width
* Head rail measurements include endcaps. Width and length measurements may vary +/- 1/8"	

Please Note: Once ordered and manufactured, the width of the Shangri-La fabric cannot be altered. Comfortex makes deductions to the width depending on the type of mounting indicated. For all mounting types, fabric will measure exactly the length ordered when the vanes are in the opened position.

Color Lux® Sheer Shadings

CORD LOOP SHADING HARDWARE SYSTEM | DESIGNER CASSETTE HEAD RAIL

Head Rail Options

Fabric Wrapped Designer Cassette Head Rail is standard. End caps of the head rail are fabric covered.

Designer Metallic Upgrade is available. Colors available: Oil Rubbed Bronze and Onyx Black. Bottom rail is always fabric wrapped.

Cord Type and Color

White, black or bronze loop cord coordinates with your hardware choice. Bead cord is optional in white, bronze, black or steel. Cord tensioners match your hardware choice (white, black or bronze). Lengths over 6 feet available in white only.

Reverse Roll

The braided cord does not have a reverse roll stop. If a shading with the Designer Cassette hardware is raised above 24" in the reverse roll mode, there is a possibility of the fabric rubbing on the head rail. Comfortex reserves the right NOT to warrant wear and tear of fabric if damaged by roll-up in excess of 24".

Length Considerations with Shangri-La Shadings

Comfortex will fabricate your Shangri-La Window Shading to the length ordered, when the vanes are in the open position (Figure A).

- When the vanes are rotated to the closed position, the shading will become slightly longer.
- When closed on an inside mount, the shading will be slightly longer than ordered length.
- Rotating the vanes closed will cause the bottom rail to touch the window sill, before it begins to raise.

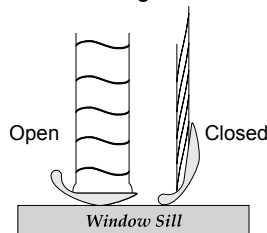

Figure A

Side By Side Alignment

When Shangri-La Window Shadings are installed side-by-side, vane alignment can be guaranteed within 1/4" only if:

- The shadings are the same color and ordered at the same time.
- The sum total of the widths of all shadings needing alignment is less than 118".

Side-by-side lineup is specified when the order is placed.

Omni-View System

Shangri-La Shadings feature the Omni-View™ Cord System. The Omni-View System provides the ability to manipulate the shading into various viewing positions. There are variations in visibility through the shadings when the vanes are tilted to their maximum open positions. The following five modes can be obtained with standard shading operation when viewing the shading at eye level.

- **Closed top, open bottom:** By partially lowering the shading from the fully raised position, the upper portion of your window will become semi-opaque while allowing a clear view below.
- **Fully private:** When lowered completely, Shangri-La provides complete privacy and softly diffused light.
- **Partially open:** Opening Shangri-La slightly will gradually increase the level of light and allow varying levels of view through.
- **View-through when lowered:** By completely opening the vanes, Shangri-La provides a softened, veiled view to the outside.
- **View-through when raised:** From the open or view-through position, continuing to pull down on the back of the cord will raise the fabric allowing a clear view outside from below, and a veiled view above. This exclusive feature allows Shangri-La to be raised up to 24" in this mode.
- Comfortex recommends that you **do not** raise the shading more than 24" off the sill in the view-through when raised mode. Refer to warranty section below for more information.
- Omni-View capability is available with all Shangri-La Shadings except cordless.

Cord Information For Shangri-La Shadings

A braided cord loop is used to raise and lower the shading. White, black or bronze loop cord matches your hardware choice. Cord tensioner will match the hardware color.

Bead cord is available in black, white, bronze and steel. Lengths over 6 feet available in white only.

The cord loop will measure the length indicated below unless otherwise specified.

Shade Length	Standard Loop
16" to 26 ⁷ / ₈ "	1' (12")
27" to 39 ⁷ / ₈ "	2' (24")
40" to 59 ⁷ / ₈ "	3' (36")
60" to 83 ⁷ / ₈ "	4' (48")
84" to 107 ⁷ / ₈ "	5' (60")
108" and greater	6' (72")

Maximum cord length is 15 feet. Polyester cord can be ordered in custom lengths in 1 foot increments only.

Braided Cord Loop Warranty Information

The shadings built with a braided cord loop do not have a reverse roll stop. If a shading is raised above 24" in the reverse roll mode, there is a possibility of the fabric rubbing on the head rail. Comfortex reserves the right NOT to warrant wear and tear of fabric if damaged by roll-up in excess of 24".

Color Lux® Sheer Shadings

RETRACTABLE CORD HARDWARE SYSTEM | DESIGNER CASSETTE HEAD RAIL

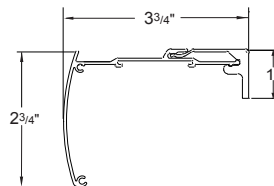
Fabric
Wrapped**Fabric Wrapped Designer Cassette Head Rail**

- Depth of rail and bracket: 3³/₄"
- Height of rail: 2³/₄"
- Height of bracket: 1"

Hardware Features

Standard Designer Cassette	Fabric Wrapped Designer Cassette is standard. Head rail endcap is fabric covered
Bottom Rail Color	Bottom rail is fabric wrapped with white end caps.

Head Rail Upgrades (*Bottom rail is always fabric wrapped*)

Designer Metallic Upgrade (Smooth Face)	<ul style="list-style-type: none"> • Oil Rubbed Bronze • Onyx Black
--------------------------------------------	---------------------------------------------------------------------------------------------

Mounting Dimensions

Mounting and Finished Dimensions are the same as Cord Loop
See Page 9

Finished Dimensions**Retractable Cord Shadings**

The Retractable Cord option is a single cord design that provides easy one hand operation to raise, lower and open and close the vanes.

- Retractable Cord hardware is an alternative to conventional cord loop controls. The short retractable cord maintains a consistent length whether the shadings are raised or lowered. The elimination of cord loop enhances child and pet safety.
- Available with all fabrics with Designer Cassette.
- White, black or bronze cord and tassel coordinates your hardware color choice.
- Standard cord length is 40% the length of the shading. Cord may be shortened to match consumer operating preferences and to keep out of reach of children. Cord length can be easily modified in the field.
- Mounting a cord tensioner is not necessary. Cord cleat is recommended.

Overall Operation

When raising and lowering the shading, pull the cord down in long, even strokes. Allow the cord to fully retract into the head rail after each downward stroke.

To Lower The Shading And Open The Vanes

- Pull the cord down toward the center of the shading with long strokes. Continue until the shading is fully lowered and the vanes are open.
- Allow the cord to retract completely into the head rail after each downward stroke.
- The shading can be stopped at any point while lowering

To Tilt The Vanes And Raise Shading

- Pull the cord straight down or down and slightly out with long strokes. With each stroke the shading partially raises.
- Allow the cord to retract completely into the head rail after each downward stroke.
- Use multiple strokes until the shading reaches the desired position.
- The shading can be stopped at any point while raising.

Color Lux® Sheer Shadings

TWO-ON-ONE HARDWARE SYSTEM | DESIGNER CASSETTE HEAD RAIL

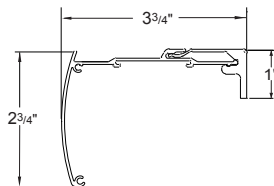
Fabric
Wrapped**Fabric Wrapped Designer Cassette Head Rail**

- Depth of rail and bracket: 3 3/4"
- Height of rail: 2 3/4"
- Height of bracket: 1"

Hardware Features

Standard Designer Cassette	Fabric Wrapped Designer Cassette is standard. Head rail endcap is fabric covered
Bottom Rail Color	Bottom rail is fabric wrapped with white end caps.

Head Rail Upgrades *(Bottom rail is always fabric wrapped)*

Designer Metallic Upgrade (Smooth Face)	<ul style="list-style-type: none"> • Oil Rubbed Bronze • Onyx Black
--------------------------------------------	---------------------------------------------------------------------------------------------

Mounting Dimensions

Mounting and Finished Dimensions are the same as Cord Loop
See Page 9

Finished Dimensions**Two-On-One Designer Cassette Head Rail**

Two-On-One Head Rail shadings are two shadings sharing the same head rail; each shading operates independently.

- Two-On-One Head Rail can be combined with cord loop, PowerTouch Rechargeable, Simplicity Motorization and retractable cord hardware options. Price as two shadings (including upgrades) and add together. Pricing example on page 6.
- Two-On-One not available with cordless.
- Specify shading total width and two individual section widths. **Note:** The two individual sections must add up to the total width.
- Two on One Head Rail Shadings are available with bead cord or braided cord loop.
- Controls will always be placed to the far left and far right.
- Available in widths up to 140" with Designer Cassette hardware.
- Minimum single section width is 12". Maximum single section width is 102". The center gap between shadings is 3/8".
- Side by side alignment is available if the two panels measure less than 120". Alignment must be specified when the order is placed.
- Shadings over 98" are subject to common carrier surcharge. See Policy PDF for more information on the freight policy.

Color Lux® Sheer Shadings

CORDLESS HARDWARE SYSTEM | DESIGNER CASSETTE HEAD RAIL



**Fabric
Wrapped**

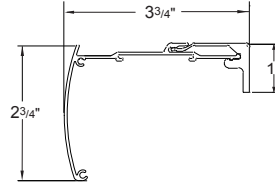

Fabric Wrapped Designer Cassette Head Rail

- Depth of rail and bracket: 3 3/4"
- Height of rail: 2 3/4"
- Height of bracket: 1"

Hardware Features	
Standard Designer Cassette	Fabric Wrapped Designer Cassette is standard. Head rail endcap is fabric covered
Bottom Rail Color	Bottom rail is fabric wrapped with white end caps and inner end caps. Handle is clear
Upgrades	
Designer Metallic Upgrade (Smooth Face)	<ul style="list-style-type: none"> • Oil Rubbed Bronze • Onyx Black
Mounting Dimensions	
Designer Cassette Head Rail	
Minimum Shallow Mount	1"
Minimum Flush Inside Mount (including brackets)	3 3/4"
Minimum Outside Mount	1"
Minimum Side Mount	1 1/4"
Maximum Side Mount	48"
Finished Dimensions	
Inside Mount	
	<ul style="list-style-type: none"> • Fabric will measure ordered width less: 7/8" • Head rail* will measure ordered width less: 3/16"
Side (End) Mount	
	<ul style="list-style-type: none"> • Fabric will measure ordered width less: 1 3/8" • Head rail* will measure ordered width less: 11/16"
Outside Mount	
	<ul style="list-style-type: none"> • Fabric will measure ordered width less: 1/2" • Head rail* will measure ordered width plus: 3/16"
Exact (End Cap to End Cap) Mount	
	<ul style="list-style-type: none"> • Fabric will measure ordered width less: 11/16" • Head rail* will measure ordered width
* Head rail measurements include endcaps. Width and length measurements may vary +/- 1/8"	

Please Note: Once ordered and manufactured, the width of the Shangri-La fabric cannot be altered. Comfortex makes deductions to the width depending on the type of mounting indicated. For all mounting types, fabric will measure exactly the length ordered when the vanes are in the closed position.

Color Lux® Sheer Shadings

CORDLESS HARDWARE SYSTEM | DESIGNER CASSETTE HEAD RAIL

Cordless Shangri-La Shadings Head Rail

- The Standard Designer Cassette head rail is fabric wrapped.
- Designer Cassette head rail is also available in Oil Rubbed Bronze and Onyx Black.
- Shangri-La Cordless Sheer Horizontal Shadings use quick-snap, no-light-gap brackets.

Cordless Shangri-La Shadings Bottom Rail

- Bottom rail includes a sliding weight to adjust fabric skewing if necessary.
- Bottom rail is always fabric wrapped.

Operating A Cordless Shangri-La Shading

Cordless Shangri-La Shadings utilize a roller catch mechanism in the head rail which allows for the vanes to be adjusted into various positions.

Pull the handle that is attached to the bottom rail until the shading reaches the desired length, allow catch mechanism to engage and lock shade in desired position.

To Open Or Close Vanes

Lower the shading all the way down and continue pulling down on the handle until the vanes open. The roller catch mechanism allows the vanes to be adjusted open, closed and to various positions in between.

When adjusting the vane position, release the catch by tugging on the handle, roll up the shading several inches (this resets the catch mechanism), then pull back down to the desired position.

- The Omni-View setting is not available with Shangri-La Cordless Shadings.

To Raise The Shading

Pull down on the handle to release the catch mechanism and let the shading rise. Tug the handle to lock the shade in the desired position.

When first learning to operate the shading, it may take a few tries to get the feel of the mechanism.



Cordless Handle



Cordless Handle Being Pulled Down

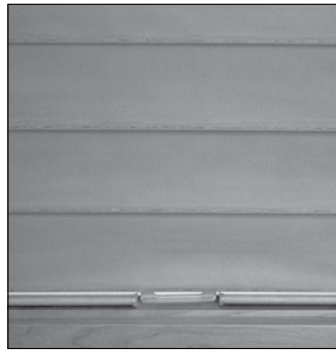

Cordless Handle on Window Sill

Color Lux® Sheer Shadings

SIMPLICITY BLUETOOTH MOTORIZATION



PRODUCT	Simplicity PowerTouch	Simplicity Remote	NEO Smart Controller	Simplicity w/ Bluetooth	Rechargeable SOMFY	12v Low Volt Hardwire
Cellular	•	•	•			•
Color Lux Cellular	•		•	•		•
Cellular Top-Down Bottom-Up		•	•			
Color Lux Cellular Top-Down Bottom-Up			•	•		
Mezzo Skylight			•	•		
Mezzo Skylight			•	•		
Color Lux Sheer Shadings	•		•	•		•
Roller - Color Lux	•		•	•		•

Benefits of Simplicity BlueTooth™ Motorization: Featuring the Free Color Lux Mobile App

- New “state of the art” 7.4v rechargeable motorization operates with both BlueTooth and Radio Frequency control technology.
- Download the new Color Lux Mobile Bluetooth App FREE on the Apple App Store for iPhone or the Google Play Store for Android.
- Optional Simplicity radio frequency remote control with choice of 5 channel, 6 channel with timer, or 14 channel remote.
- Optional Simplicity Smart Controller (NEO) for remote operation of shades which integrates with Amazon Alexa and Google Assistant devices.

Features of the Color Lux Mobile Bluetooth App:

- Controls your shade directly from your phone with Bluetooth control.
- Has a shade position display indicator. See screen to the right.
- Has a battery charge level indicator.
- Controls the shade using easy swipe or control buttons.
- Controls up to 5 shades simultaneously and no limit to the number of shades connected to a single account.
- Has timer and scene setting options.

Please Note: There are many factors affecting Bluetooth range

- Physical obstacles in the transmission path
- The antennas should be exposed for best performance
- Bluetooth 4.2 supports 10 meters indoor range (~33 feet).

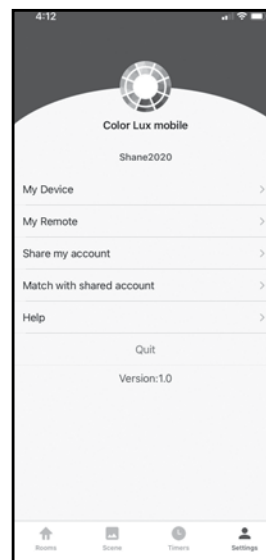

Color Lux Mobile App Main Screen

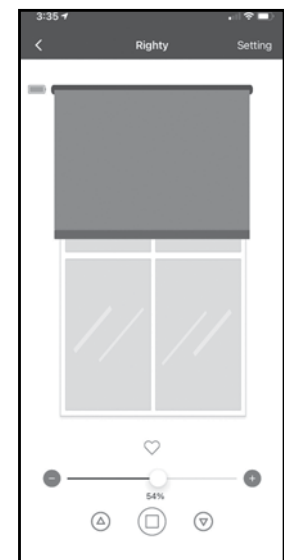

Color Lux Mobile App Control Screen

Color Lux® Sheer Shadings

7.4V RECHARGEABLE POWERTOUCHE HARDWARE SYSTEM | DESIGNER CASSETTE HEAD RAIL

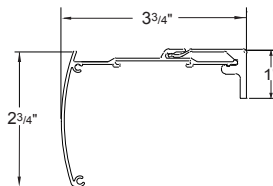
Fabric
Wrapped**Fabric Wrapped Designer Cassette Head Rail**

- Depth of rail and bracket: 3 3/4"
- Height of rail: 2 3/4"
- Height of bracket: 1"

Hardware Features

Standard Designer Cassette	Fabric Wrapped Designer Cassette is standard. Head rail endcap is fabric covered
Bottom Rail Color	Bottom rail is fabric wrapped with white end caps.

Head Rail Upgrades *(Bottom rail is always fabric wrapped)*

Designer Metallic Upgrade (Smooth Face)	<ul style="list-style-type: none"> • Oil Rubbed Bronze • Onyx Black
--------------------------------------------	---------------------------------------------------------------------------------------------

Mounting Dimensions**Designer Cassette Head Rail**

Minimum Shallow Mount	1"
Minimum Flush Inside Mount (including brackets)	3 3/4"
Minimum Outside Mount	1"
Minimum Side Mount	1 1/4"
Width Side Mount	48" Max width side mount

Finished Dimensions**Inside Mount**

- Fabric will measure ordered width less: 1"
- Head rail* will measure ordered width less: 3/16"

Side (End) Mount

- Fabric will measure ordered width less: 1 1/2"
- Head rail* will measure ordered width less: 1 1/16"

Outside Mount

- Fabric will measure ordered width less: 5/8"
- Head rail* will measure ordered width plus: 3/16"

Exact (End Cap to End Cap) Mount

- Fabric will measure ordered width less: 1 3/16"
- Head rail* will measure ordered width

* Head rail measurements include endcaps. Width and length measurements may vary +/- 1/8"

Please Note: Once ordered and manufactured, the width of the Shangri-La fabric cannot be altered. Comfortex makes deductions to the width depending on the type of mounting indicated. For all mounting types, fabric will measure exactly the length ordered when the vanes are in the open position.

Color Lux® Sheer Shadings

7.4V RECHARGEABLE POWERTOUCH HARDWARE SYSTEM | DESIGNER CASSETTE HEAD RAIL

PowerTouch™ Rechargeable Shades

Sheer Shadings can be fabricated with the PowerTouch Rechargeable Push Button Control option. The PowerTouch Rechargeable option is an easy, cord free motorized operation for the budget savvy homeowner. PowerTouch Rechargeable uses Simplicity motors and components.

PowerTouch Rechargeable Shades Operation

Press the up or down button on the pendant to raise or lower the shading to your desired position. When the shading is fully lowered to the factory programmed lower limit, the bottom rail will be set in the level position.

No programming is required with PowerTouch™, all programming is set at the factory. Upper and lower limits easily can be adjusted in the field if desired. Please refer to the installation instructions at comfortex.com/comfortex-dealers. Favorites position can be programmed on-site.

PowerTouch Rechargeable Surcharges

See page 5.

PowerTouch Appearance

- The PowerTouch Rechargeable wand and pendant is attached to the head rail and requires no additional mounting.
- The wand and pendant hangs down the front of the shades from the head rail. The wand does not touch the fabric.
- Pendant is 2½" long.
- The pendant does not need to be mounted to the wall to operate the shade.



PowerTouch Rechargeable Color Options

- Shadings with Black or Oil Rubbed Bronze hardware will be built with black wand and pendants standard. All other colors will use white wand and pendants.



White



Black Shown with Plug-In Charger

PowerTouch Rechargeable Wand Length

The standard length of the wand will measure the indicated below unless otherwise specified.

Shading Length	Standard Wand Length
Up to 30"	1' (12")
>30" to 52"	2' (24")
>52" to 78"	3' (36")
>78" to 100"	4' (48")
>100" to 120"	5' (60")

- Wand length is in 1 foot increments. 1 foot - 5 foot

Mounting Requirements for PowerTouch Rechargeable Shadings

- No special installation hardware or wiring requirements are needed.
- The wand and pendant do not need to be mounted to operate the shading.

Integrated Rechargeable Motor Battery Life

Rechargeable battery is included with the motor.

The average battery charge will last 6-12 months based on an average sized shade raised and lowered once per day. The life of the battery charge will vary based on the type of window covering selected, the size and weight of the window covering and the number of times the shade is operated on a daily basis.

The battery can be recharged up to 500 times. It takes approximately 5 hours to recharge the motor when fully depleted.

Battery Charger

8.4 Volt charger requires a standard power outlet to recharge the battery. Must specify charger when ordering a Simplicity PowerTouch Rechargeable Shading. The charger plugs into the charger port. The charger is black and comes with a 156" wire. The dimensions are 1" wide x 2½" length x 1¾" deep.



PowerTouch Wand and Pendant Location

The standard location for the wand and pendant is on the right. Please specify location when ordering.

Color Lux® Sheer Shadings
12V NON-RECHARGEABLE SIMPLICITY MOTORIZATION | DESIGNER CASSETTE HEAD RAIL _____



Fabric Wrapped

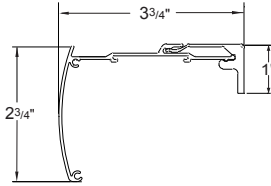

Smooth Face Designer Cassette Head Rail

- Depth of rail and bracket: 3 3/4"
- Height of rail: 2 3/4"
- Height of bracket: 1"

Hardware Features

Standard Designer Cassette	Fabric Wrapped Designer Cassette is standard. Head rail endcap is fabric covered
Bottom Rail Color	Bottom rail is fabric wrapped with white end caps.

Head Rail Upgrades *(Bottom rail is always fabric wrapped)*

Designer Metallic Upgrade (Smooth Face)	<ul style="list-style-type: none"> • Oil Rubbed Bronze • Onyx Black
-----------------------------------------	---------------------------------------------------------------------------------------------

Mounting Dimensions	Designer Cassette Head Rail
Minimum Shallow Mount	1"
Minimum Flush Inside Mount (including brackets)	3 3/4"
Minimum Outside Mount	1"
Minimum Side Mount	1 1/4"
Width Side Mount	48" Max width side mount

Finished Dimensions

Inside Mount	
	<ul style="list-style-type: none"> • Fabric will measure ordered width less: 1" • Head rail* will measure ordered width less: 3/16"
Side (End) Mount	
	<ul style="list-style-type: none"> • Fabric will measure ordered width less: 1 1/2" • Head rail* will measure ordered width less: 1 1/16"
Outside Mount	
	<ul style="list-style-type: none"> • Fabric will measure ordered width less: 5/8" • Head rail* will measure ordered width plus: 3/16"
Exact (End Cap to End Cap) Mount	
	<ul style="list-style-type: none"> • Fabric will measure ordered width less: 13/16" • Head rail* will measure ordered width

* Head rail measurements include endcaps. Width and length measurements may vary +/- 1/8"

Please Note: Once ordered and manufactured, the width of the Shangri-La fabric cannot be altered. Comfortex makes deductions to the width depending on the type of mounting indicated. For all mounting types, fabric will measure exactly the length ordered when the vanes are in the open position.

Color Lux® Sheer Shadings

12V NON-RECHARGEABLE SIMPLICITY MOTORIZATION | DESIGNER CASSETTE HEAD RAIL _____

Non-Rechargeable Simplicity Motors

The non-rechargeable Simplicity Motor program features a battery powered motor utilizing a single battery wand that contains disposable AA batteries or plug-in DC transformer. Simplicity motors are compact and use a radio frequency remote to raise or lower the shadings. The Simplicity motor is concealed in the head rail.

See page 20 for information on Simplicity Rechargeable system version.

Simplicity Motors With Designer Cassette

No special installation hardware or wiring requirements are needed to install motorized Shangri-La Shadings with Designer Cassette Head Rail. See page 18 for mounting information.

Simplicity Battery Wand

The battery wand can be clipped to the Designer Cassette head rail. Can not be mounted on shadings under 25" wide. The battery wand is wall or ceiling mounted utilizing white battery wand clips. The 12 volt battery wand measures 17¼", and comes with eight alkaline batteries, and is white in color. The battery wand must be placed so it does not interfere with the mounting brackets.

The battery wire is 10" long. A 48" extension wire is available.



Simplicity Motor Battery Life and Replacement

Eight alkaline batteries are included with the wand. The battery life will vary based on the type of window covering selected, the size and weight of the window covering and the number of times you operate the shade on a daily basis.

Comfortex will warranty batteries for up to 3 months from date of purchase. Batteries are not covered by the warranty.

DC Power Supply/Transformer

12 Volt DC power supply/transformer is available and requires a standard power outlet to power the motor. The transformer is an alternative to a battery wand. Each transformer can power a single shading. The power supply must plug in to the motor. The DC power supply is black and comes with a 80" wire. The dimensions are 1⅞" wide x 3¼" long x 1¼" deep. Extension wires are available if needed.



Important Simplicity Motorized Shading Operating and Installation Information

Simplicity Motorized Shadings installed into windows with metal casings may have a reduced radio frequency range, or may not operate at all, depending on the application

Simplicity Motor Hand Held Remotes

IMPORTANT: Simplicity Rechargeable Motorized Shadings are programmed at the factory with the "up and down" limits. The shades are **UNLINKED** from the remote so they are not able to operate during shipping. Each shade should be installed **before** linking it to the remote.

Simplicity Hand Held Remote 14 Channel Remote

The TDBU remote has 14-channels. This remote is required for TDBU motorization but can be utilized on all Simplicity motorized shades. Each channel has a setting to operate the middle rail and a setting to operate the bottom rail. The TDBU remote is required for TDBU motors. The **14 Channel TDBU remote** can operate up to fourteen shades individually or 14 groups. Simplicity Rechargeable Motorized Cellular Shades are programmed at the factory with the "up and down" limits. The shades are **UNLINKED** from the remote so they are not able to operate during shipping. Each shade should be installed **after** linking it to the remote.



Simplicity TDBU remotes and holders are white or black in color. The remote comes with a holder which can be mounted to a wall for easy storage. The range of the remote is approximately 80 feet.

Please Note:

- Not all motors run at the same rate of speed.
- Simplicity motors have a "Favorites" or "MY" position setting. If the homeowner wants to set several shadings at the same intermediate position, follow instructions provided with installation manual.

Simplicity Battery Operated Motorized Shadings Warranty

Please Policy PDF for complete Comfortex warranty information.

NEW Simplicity Bluetooth Motorization

Learn about Simplicity Bluetooth motorization and Comfortex FREE Color Lux Mobile App on [page 15](#).

Color Lux® Sheer Shadings

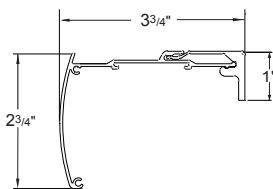
7.4V RECHARGEABLE SIMPLICITY HARDWARE SYSTEM
WITH QUIETUDE™ TECHNOLOGYFabric
Wrapped**Fabric Wrapped Designer Cassette Head Rail**

- Depth of rail and bracket: 3 3/4"
- Height of rail: 2 3/4"
- Height of bracket: 1"

Color Lux 7.4V rechargeable Simplicity features Bluetooth communication.



New "state of the art" 7.4v rechargeable motorization operates with both Bluetooth and Radio Frequency control technology.

Hardware Features

Standard Designer Cassette	Fabric Wrapped Designer Cassette is standard. Head rail endcap is fabric covered
Bottom Rail Color	Bottom rail is fabric wrapped with white end caps.
Head Rail Upgrades (<i>Bottom rail is always fabric wrapped</i>)	
Designer Metallic Upgrade (Smooth Face)	<ul style="list-style-type: none"> • Oil Rubbed Bronze • Onyx Black

Mounting Dimensions**Designer Cassette Head Rail**

Minimum Shallow Mount	1"
Minimum Flush Inside Mount (including brackets)	3 3/4"
Minimum Outside Mount	1"
Minimum Side Mount	1 1/4"
Width Side Mount	48" Max width side mount

Finished Dimensions

Inside Mount	
	<ul style="list-style-type: none"> • Fabric will measure ordered width less: 1" • Head rail* will measure ordered width less: 3/16"
Side (End) Mount	
	<ul style="list-style-type: none"> • Fabric will measure ordered width less: 1 1/2" • Head rail* will measure ordered width less: 1 1/16"
Outside Mount	
	<ul style="list-style-type: none"> • Fabric will measure ordered width less: 5/8" • Head rail* will measure ordered width plus: 3/16"
Exact (End Cap to End Cap) Mount	
	<ul style="list-style-type: none"> • Fabric will measure ordered width less: 13/16" • Head rail* will measure ordered width
* Head rail measurements include endcaps. Width and length measurements may vary +/- 1/8"	

Please Note: Once ordered and manufactured, the width of the Shangri-La fabric cannot be altered. Comfortex makes deductions to the width depending on the type of mounting indicated. For all mounting types, fabric will measure exactly the length ordered when the vanes are in the open position.

Color Lux® Sheer Shadings

7.4V RECHARGEABLE SIMPLICITY HARDWARE SYSTEM

WITH QUIETUDE™ TECHNOLOGY



Bluetooth Simplicity Rechargeable Motors

The Rechargeable Simplicity Motor program features an integrated rechargeable lithium ion battery in the motor casing and is fully concealed by the roller tube.

PowerTouch Integrated Rechargeable Surcharges

See page 3 for shading standards and page 5 for surcharges and pricing example.

Simplicity Rechargeable Motors

No special installation hardware or wiring requirements are needed to install motorized Shangri-La Shadings with Designer Cassette Head Rail. No external battery wand is required. See page 16 for mounting information.

Rechargeable Simplicity Motor Batteries

The battery for the integrated rechargeable simplicity motor system is integrated within the motor casing and is fully concealed by the roller tube.

Rechargeable battery comes fully charged from the factory.

Integrated Rechargeable Motor Battery Life

The rechargeable battery is concealed within the motor housing.

The average battery charge will last 6-12 months based on an average sized shade raised and lowered once per day. The life of the battery charge will vary based on the type of window covering selected, the size and weight of the window covering and the number of times the shade is operated on a daily basis.

The battery can be recharged up to 500 times. It takes approximately 5 hours to recharge the motor when fully depleted.

Integrated Rechargeable Motor Battery Charger

An 8.4 Volt charger requires a standard power outlet to recharge the battery. The charger must be specified when ordering an Integrated Rechargeable Simplicity Motorized shade. The charger plugs into the charging port of the motor. Required with Integrated Shading order. Sold separately.



The charger is black and comes with a 156" wire. The dimensions are 1" wide x 2½" length x 1¾" deep.

Simplicity Motor Hand Held Remotes

IMPORTANT: Simplicity Rechargeable Motorized Shadings are programmed at the factory with the "up and down" limits. The shades are **UNLINKED** from the remote so they are not able to operate during shipping. Each shade should be installed **before** linking it to the remote.

Simplicity Hand Held Remote 14 Channel Remote

The TDBU remote has 14-channels. This remote is required for TDBU motorization but can be utilized on all Simplicity motorized shades. Each channel has a setting to operate the middle rail and a setting to operate the bottom rail. The TDBU remote is required for TDBU motors. The **14 Channel TDBU remote** can operate up to fourteen shades individually or 14 groups. Simplicity Rechargeable Motorized Cellular Shades are programmed at the factory with the "up and down" limits. The shades are **UNLINKED** from the remote so they are not able to operate during shipping. Each shade should be installed **after** linking it to the remote.



Simplicity TDBU remotes and holders are white or black in color. The remote comes with a holder which can be mounted to a wall for easy storage. The range of the remote is approximately 80 feet.

Please Note:

- Not all motors run at the same rate of speed.
- Simplicity motors have a "Favorites" or "MY" position setting. If the homeowner wants to set several shadings at the same intermediate position, follow instructions provided with installation manual.
- **WHEN ORDERING THE NEW INTEGRATED RECHARGEABLE, PLEASE ORDER THE NECESSARY BATTERY CHARGER.**

Solar Panel Recharge Option

Plugs in to any Simplicity Rechargeable Remote control shade (does not work with PowerTouch). See page 22.

Color Lux® Sheer Shadings

7.4V RECHARGEABLE SIMPLICITY HARDWARE SYSTEM

WITH QUIETUDE™ TECHNOLOGY

Important Information about Integrated Rechargeable Simplicity Motor Shading Operation and Installation

- Simplicity Motorized Shadings installed into windows with metal casings may have a reduced radio frequency range, or may not operate at all, depending on control.
- Be mindful of when your shade starts to slow down during operation. It is a good indicator the shade needs to be recharged.

Simplicity Battery Operated Motorized Shadings Warranty

Please see Policy PDF for complete Comfortex warranty information.

NEW Simplicity Bluetooth Motorization

Learn about Simplicity Bluetooth motorization and Comfortex FREE Color Lux Mobile App on page 15.



Solar Panel Recharge Option

Plugs in to any Simplicity Rechargeable Remote control shade (does not work with PowerTouch)

Provides constant trickle charge to 7.4v Li-Ion Rechargeable battery packs. Will prolong the life of the charge of the 7.4v rechargeable battery packs, and in some applications will maintain charge indefinitely.

Life of charge is subject to application variables such as, size and weight of shade, frequency of use, amount of direct sunlight exposure, etc.

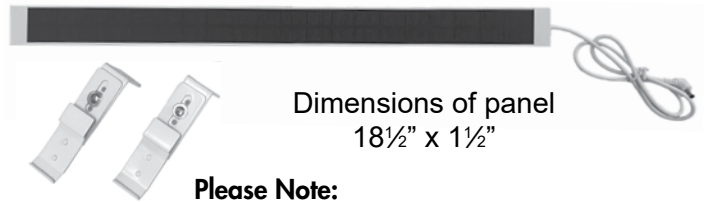

Dimensions of panel
18½" x 1½"

Please Note:

LED solar panel cord length is 24". Make sure to order 48" extension cord if needed.

Solar Recharge Optimum Application

- Full direct sunlight (minimum 2 hours per day) to maintain full charge. Based on one operation cycle per day (one open, one close).
- Excessive duration of cloudy weather will impact the rate of charge.

Solar Panel LED Lights

Red Light: Indicates optimum direct sun exposure

Green Light: Indicates sunlight is enough to charge battery

Blue Light: Indicates battery is charging. Blue light is off when not charging (including when the battery is full)

No Lights: Night or very low sun

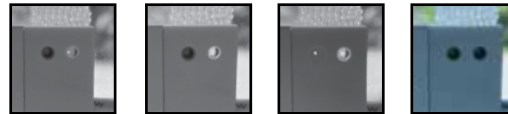

Red Light Green Light Blue Light No Light

Solar Panel Mounting

Bottom portion of the bracket may be lowered if needed for more sun exposure. Bracket can be mounted behind or next to shade mounting bracket.

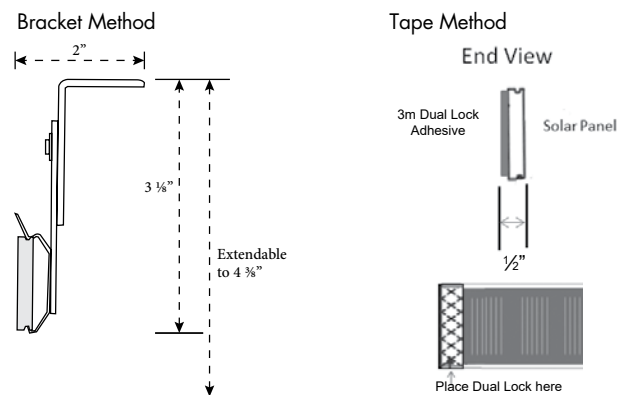

Tape goes on the face (black side) of the panel.

If the solar panel is mounted directly behind the headrail at the top of the window, you need to make sure that the solar panel does not interfere with the shade mounting brackets. The solar panel can go between brackets spaced apart, or behind brackets if the depth of the window casing allows.

Color Lux® Sheer Shadings

7.4V RECHARGEABLE SIMPLICITY HARDWARE SYSTEM

EZ Charge Extension Wand Option

EZ Charge Extension Wand is the newest innovation in rechargeable motorization. Easily charge your hard to reach Simplicity Rechargeable Shades with the EZ Charge Extension Wand. The wand extends up to 31" in length.

Simple to use! Place the magnetized wand tip on the receiving port to attach. Then plug the charger into the base of the wand. It is that simple!

- EZ Charge Extension Wand can be easily concealed by a valance or drapery panel.
- Great for out of reach windows

EZ Charge Wall Mount Receiver

- The EZ Charge Wall Mount Receiver includes screws and anchors. These can be used for wood or drywall mounting.
- Extension cable plugs into charging port of Simplicity Rechargeable shades.

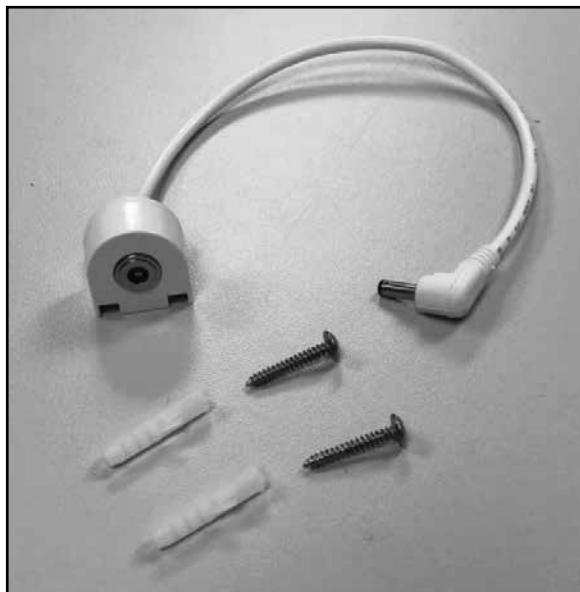

EZ Charge Wall Mount Receiver Kit | CKIT078
 One kit per Simplicity Motorized shade is needed.

EZ Charge Wand

- Wand is 9½" and extends to 31"
- Magnetized tip makes connection quick and easy.
- Once wand is in place plug the 8.4v charger into the bottom of the extension wand for charging.

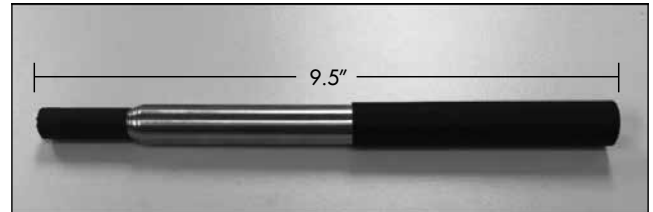

EZ Charge Wand | CKIT077
 Order with the EZ Charge Wall Mount Receiver Kit



EZ Charge Receiving Port



Port/Wand Connection

Shade/Blind Product	EZ Charge Wall Mount Receiver List Price	EZ Charge Wand List Price
Sheer	\$18	\$32



Battery Charger



Wand Base

Battery Charger - SOLD SEPARATELY

You must specify charger when ordering a Simplicity Rechargeable Motorized Shade. The charger plugs into the wand base. The 8.4 Volt charger requires a standard power outlet to recharge the motor. The charger is black and comes with a 156" wire. The dimensions are 1" wide x 2½" length x 1¾" deep.

Color Lux® Sheer Shadings
FRICITION FIT MOUNTING SYSTEM | DESIGNER CASSETTE

FRICITION FIT MOUNTING SYSTEM

The Friction Fit Mounting System is the perfect solution for hard to drill materials and where drilling is not desired or allowed. There is **NO BRACKET INSTALLATION REQUIRED**.

This pressure mounted system utilizes an aluminum rail designed with a high tension spring that is pre-fabricated with your ordered shade. **INSTALLATION BRACKETS** for your ordered shade **ARE PRE-ATTACHED AT THE FACTORY** for easy installation on site.

To install, simply insert the rail within the window opening and secure the lever. This increases the pressure to the ends of the rail, allowing for a snug fit in the window opening.

Manufacturer's List Price: \$94

Friction Fit is ideal for many applications, such as:

- Brick
- Concrete
- Cinderblock
- Steel*
- Aluminum*
- Tile*
- Popcorn and other textured finishes
- Wood

* Smooth surfaces will require use of included double-sided adhesive.

LEVER LOCATION

The lever will always be on the clutch side for cordloop shades. For cordless and motorized, it will always be on the right.

Deductions for Cordless and Designer Cassette shades will be unchanged.

Minimum Mounting Depth is 2 1/8"

Maximum width for all mounting systems is 84".

COLOR OPTIONS

Friction Fit Mounting System is available in white and black.



White Rail



Black Rail

OPERATION TYPES

Inside Mount Only

- Skyline Standard Roller Shades (R-series not available)
- FeatherTouch Cordless
- Cordless Deco-Bar
- Motorization (Rechargeable, Non-Rechargeable, PowerTouch and Hardwired)

Designer Cassette is available with cordless and motorized shades. Designer Cassette with cordloop is **NOT** available.

RAIL PROJECTIONS

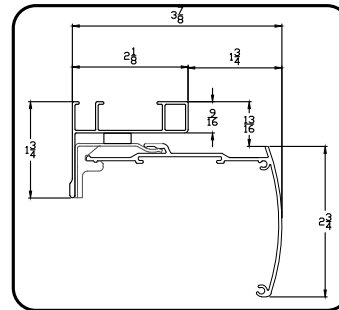

Designer Cassette End View

Color Lux® Sheer Shadings

12V SIMPLICITY LOW VOLTAGE HARDWIRING SYSTEM

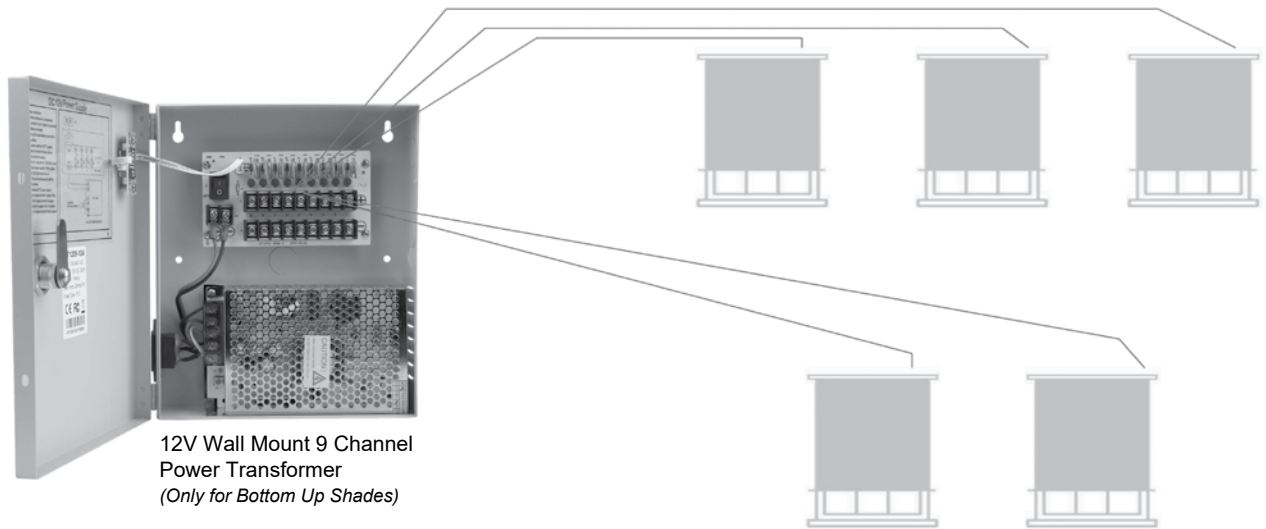

12V Low Voltage Hard Wired

Low Voltage hardwire powered motors are available for Roller Shades, Sheer Shadings and Cellular bottom up shades. The system offers a maintenance-free power option for Simplicity Motorized Shades. Our Simplicity power transformer mounts in a safe dry location (such as your basement), out of sight, and provides power for up to nine individual shades per box.

2 Conductor wires should be pre-installed by a licensed contractor according to local building codes, to connect power from the transformer to the shades.

Simply use the wire adapters provided to connect the power wire to the Simplicity motor power input on the back of the shade, then connect the pre-run wires to the (+ / -) terminal block in the transformer box, and flip on the power switch.

- Product Dimension: 7.875" wide, 9.4" Tall, 2.45" deep
- Converts incoming 120V AC to outgoing 12V for up to 9 shades.

- **Product Description:**

- 12v10a 9ch
- Input Voltage Range : AC90V-264V
- Input Frequency Range : 50Hz-60Hz
- Output Voltage Range : DC12V+/-5%
- Output Current : 10 Ampere
- Output Power : 120 Watt
- Output Ripple&Noise : ≤42MV
- Output Efficiency : ≥83%
- Output Fuse Type : PTC
- Output Fuse Rating : 2A
- Environment Operating Amb.Temp : -30 ~45
20%~90%RH
- Environment Storage Temp : -40 ~85 10%~95%RH
- Plugs into standard household outlet
- Power cord is 56" in length

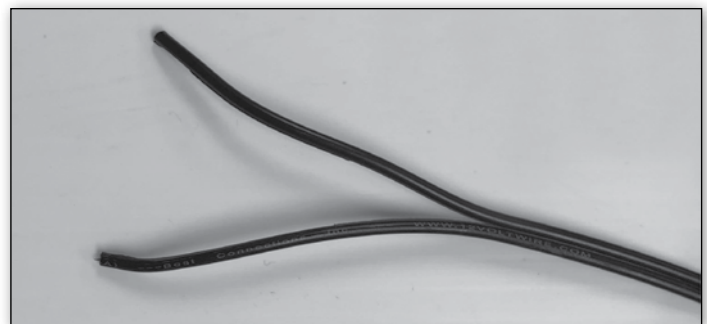

2 Conductor Wires running to basement 12V Power Transformer



Power port on back of shade

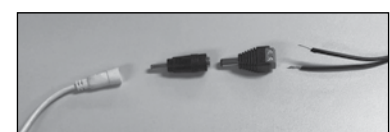

Wires connecting to charging port on Simplicity shade



12V Wall Mount 9 Channel Power Transformer

Color Lux® Sheer Shadings **SIMPLICITY SMART CONTROLLER**



Simplicity Smart Controller Dimensions

- Width of controller: 2³/₈"
- Length of controller: 2¹⁵/₁₆"
- Height of controller: 1¹/₈"

Simplicity Smart Controller	
	<ul style="list-style-type: none"> • Works with Apple and Android devices • FREE Downloadable Application • Compatible with previously installed Simplicity Remote Controlled Shades • Powered by NEO Smart Blinds App. • Compatible with Amazon Alexa, Google Assistant systems, Control4 and Savant systems

Simplicity Smart Controller

The Simplicity Smart Controller is a small device that you install in your home that allows you to set automatic opening and closing times for all Simplicity motorized shades as well as the ability to control your motorized shades from a phone, tablet or PC from anywhere in world.

The Simplicity Smart Controller will work with any Comfortex remote motorized shade with Simplicity remote control motors purchased after 2012.

The Simplicity Smart Controller plugs into a standard electrical outlet and connects to WiFi and sends signals to your shades using the same radio frequencies as a normal remote control.

How Does The NEO Smart Blinds App Work?

The app uses WiFi or cellular data to send commands over the internet to the Simplicity Smart Controller.

Do I Need Any Other Equipment?

Yes, The location where your shades are installed must have WiFi in order for the Simplicity Smart Controller to work. Additionally, you must have a smartphone or tablet running Android or iOS (eg. iPhone, iPad, Samsung Galaxy S7) and have the NEO Smart Blinds app. installed.

Why Would I Want A Simplicity Smart Controller?

There are two main ways the Simplicity Smart Controller adds additional value to your motorized shades. First, once all of your shades have been added, you can use your smartphone as a single remote for all of your shades that will work anywhere you are regardless of distance from the shade. Secondly, the device allows you to set schedules so your motorized shades automatically open and close without needing to do anything on a day to day basis.

Do I Need To Buy More Than 1 Controller?

The normal use for the Simplicity Smart Controller is to plug it in out of the way and forget it. Since it has roughly the same range as a remote you will want enough devices to allow all shades to be operated without moving the controller. So depending on the layout of the home and location of the shade, you might want multiple devices to have convenient full home coverage.

How Far Is The Range Of A Controller?

You should see a range of approximately 150 ft. However this number might be less depending on the layout of your home. In general we recommend one per a floor of a normal sized home.

Can I Control My Shades From Multiple Devices?

Yes! You can download the NEO Smart Blinds App onto multiple devices, After installing the App. on a new device simply log in with the same email/password on each device and you will have access to control your shades.

Can It Be Used With Already Installed Shades?

Yes! Simply follow the directions in the NEO Smart Blinds app. to add a shade. At the pairing step you can put the shade in pairing mode using the primary remote control (or by accessing the button on the shades motor). Adding the shade to the NEO Smart Blinds App. will not affect the normal remote operation.

How Much Does The NEO Smart Blinds App Cost?

The App is a free download, However you must have at least one Simplicity Smart Controller to serve as a bridge between the App and your shades.



UV Protection



Cleaning & Care



Vane Opening & Closure



Child Safety



Measuring



Mounting

Color Lux® Sheer Shadings

GENERAL INFORMATION

Certified Fabrics | GREENGUARD® Fabrics

GREENGUARD Environmental Institute has established performance based standards to define goods with low chemical and particle emissions for use indoors.

The Shangri-La fabrics have the passed GREENGUARD Indoor Air Quality Certified® certification program for low emitting interior building materials, furnishings, and finish systems.

Flame Resistance

Shangri-La fabric may be processed with a topical treatment to resist flames and adhere to strict flammability codes. For more information, contact Customer Service at (800) 843-4151.

UV Protection

Ultraviolet light, entering the home as sunlight, damages furnishings. In time it fades wood floors, furniture, upholstery, draperies, carpeting and artwork. Prolonged exposure to sunlight causes natural, undyed fabrics to turn yellow, weakening their fibers and making them look old and worn prematurely.

The right window covering can be very effective in blocking ultraviolet rays. Such effectiveness is measured in terms of a "% UV blockage" rating. The higher the rating, the greater the UV protection.

Shangri-La fabrics have the following UV Protection ratings:

Light Filtering Fabrics	Open Vanes	87%
Room Darkening Fabric	Open Vanes	88%
All Fabrics	Closed Vanes	99%

Vane Closure

Shangri-La vanes are not designed to close tightly. The inherent nature of the fabric will cause a slight increase in the distance from the front sheer to back sheer as you move further down the shading. These vanes do not form a perfect seal against light leakage which is most visible toward the bottom of the shading. Vane overlap ensures that privacy is not compromised.

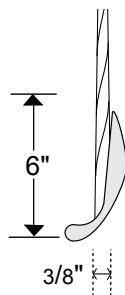

Vane closure is measured as the distance between the front and rear fabric sheers 6" up from the lowest point of the bottom rail, with the shading fully lowered and the vanes closed.

On light filtering fabrics, the maximum distance from the front sheer to the back sheer when closed is equal to or less than 3/8" for shadings under 60" and 5/8" for shadings longer than 60". On room darkening fabrics, the distance is 3/8" regardless of shading length.

Vane Opening and Visibility

Vaness on the three styles of Shangri-La fabrics open to slightly different degrees. Consequently, there are variations in visibility through the shadings when the vanes are tilted to their maximum open positions. The variations among the products are shown in the below illustration when looking through the shading 1/4 of the way up from the bottom.

3" Fabrics

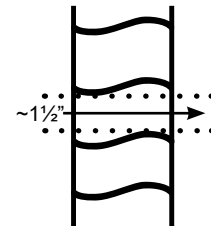

Magnetic Hold-Down Brackets

Optional magnetic hold-down brackets secure the bottom of the shading to prevent swaying. Please specify when ordering.

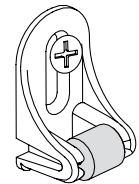

Extension Brackets

Extension or "L" brackets are available to project the back of the shading from the mounting surface. The extension brackets for Designer Cassette head rail projects it 3".

Spacer Blocks

Spacer blocks project the shading 3/8" from the mounting surface. Use spacer blocks to obtain clearance when obstructions, such as window cranks or door handles, obstruct the movement of the shading.

Leveling Shangri-La Sheer Shadings

Shangri-La Window Shadings are leveled and weighted in the factory. When installed level, the fabric will not skew when raised. If the head rail is not installed level, skewing can occur that can damage the edge of the fabric. Be sure to follow the installation instructions carefully to ensure correct and balanced operation.

Bracket Shims

Bracket shims may be used whenever the mounting surface is uneven in order to mount the blind level. Shims are a no-charge option, but must be specified when ordering your shades.

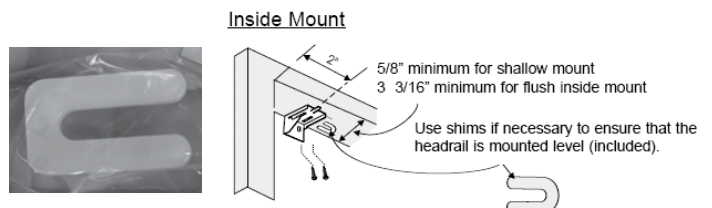

Color Lux® Sheer Shadings

GENERAL INFORMATION

Measuring Instructions for Sheer Shadings

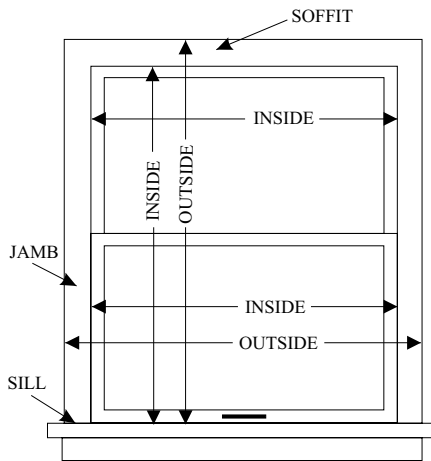

Important Measuring Guidelines for Sheer Shadings. Comfortex accepts measurements down to 1/16" increments.

Precise width and length measurements are critical. Fabric width cannot be altered after the shading is fabricated.

Please use a metal tape measure for accuracy.

The head rail must be installed perfectly level to ensure smooth operation. On an inside mount, it is recommended that you check to see that the mounting surface is level and consistent. If your soffit needs to be leveled, this should be done before measuring.

Inside Mount

Measure across the width of your window opening in three different places - top, middle and bottom. Measurements should be taken within the window jamb. Provide the smallest of the three measurements to Comfortex. Be exact. Comfortex will make the necessary deductions to fit the window opening.

Measure the length of the window opening from the underside of the soffit to the surface of the window sill in two places - use the smallest of these two measurements.

Outside Mount

Measure the exact width and length of the area to be covered. On the width, allow at least 1 1/2" of an overlap on each side. An overlap of 3" on each side is recommended. Be sure to take into consideration any obstructions such as window trim, molding, locks and window cranks.

Side Mount

Side mount is not available with DoorStyles Shadings.

Shangri-La may be side mounted using "L" brackets. For side mounts, follow the instructions for inside mounts. An additional 1/2" will be taken off the standard inside mount deduction to allow room for the "L" brackets.

The maximum shading width utilizing the side mount option is 48".

Skew Adjusting Bottom Rail

After installation, windows that are not square and level may cause the shadings to shift to one side as it rolls up, requiring adjustment of the bottom rail. If the brackets are not level it may be necessary to adjust the bottom rail weight.

- To access the bottom rail weight, release the weight clip on the bottom rail by using a flat blade screwdriver. Insert it into the weight clip in the bottom rail and turn clockwise.
- Move the weight in 1" increments toward the side where the fabric is gathering.
- Secure the weight clips in position by turning them counterclockwise after making the adjustment.

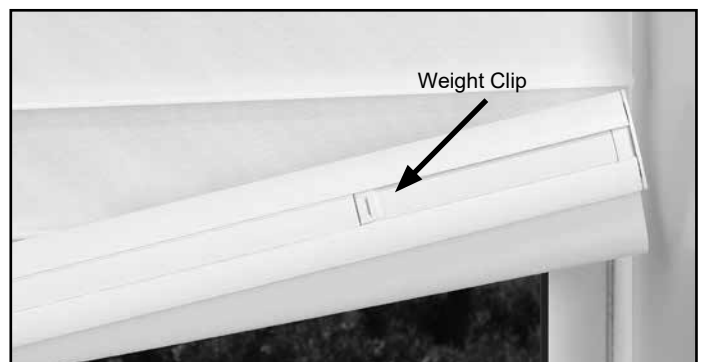

Cleaning and Care

Shangri-La Shadings are made from a sturdy, knitted polyester fabric which can be feather dusted or vacuumed at a low setting. Spots or stains can be lightly rubbed clean with a damp sponge and mild soap. To avoid discoloration of the material, we recommend against the use of chemical cleaners.

Precautions should be taken to reduce exposure to harsh environmental elements, such as salt air. Continuous exposure to salt air through open windows and doors will accelerate fabric deterioration over time.

Important: Do not clean the fabric using electrostatic wipes such as Swiffer® or Pledge Grab-It®.

Ultrasonic Cleaning

Shangri-La Shadings can be ultrasonically cleaned. Adco OnSite Fabricare provides shading and blind cleaning services. For more information, visit www.onsitefabricare.com. Comfortex acknowledges these cleaning methods as being safe and effective. We cannot attest to the quality of equipment or services provided by any independent cleaning facility.

For additional advice on care or cleaning, please contact the Comfortex Technical Service Department at 800-843-4151.

Color Lux® Sheer Shadings

GENERAL INFORMATION

⚠️ WARNING

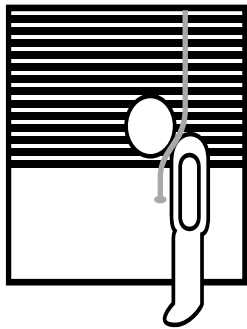

Window Blind Cord Can STRANGLE Your Child.

To prevent strangulation, purchase cordless products or products with inaccessible cords.

⚠️ ADVERTENCIA

La cuerda ciega de la ventana puede ESTRANGULAR su niño.

Para evitar el estrangulamiento, compre alternativas inalámbricas o productos con cables inaccesibles.

Child Safety

All Comfortex products have been fully tested and proven to comply with the current WCMA Standards for Safety of Window Covering Products.

Be aware that it is possible for children to become entangled in window covering cords. To reduce the risk of accidents, all cords must be kept out of the reach of children.

Cord Tensioners

Cord tensioners used on Shangri-La and Soft Tones Shadings continuous cord loops keep the continuous cord loops taut to prevent children and pets from becoming entangled and subsequently injuring themselves. Cord tensioners must be used with Shangri-La and Soft Tones Shadings to comply with the Consumer Product Safety Commission (CPSC) and WCMA Child Safety Guidelines.

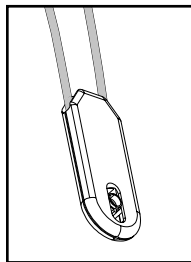

Cord Tensioner

Shangri-La Shadings with Retractable Cord Hardware

Retractable Cord hardware is safe alternative to conventional cord loop controls by retracting and limiting the cord length. We recommend using cord cleats.

COLOR LUX SHEER SHADINGS

	Page
Hardware Options	1
Size Standards	3
Hardware Options Pricing	5
 PRICE GRIDS	
3" Vanes Cord Loop - Light Filtering Price Group 1	7
3" Vanes Cord Loop - Room Darkening Price Group 2	7
 HARDWARE	
Cord Loop Hardware	9
Retractable Cord Hardware	11
Two-On-One Hardware	12
Cordless Hardware	13
Simplicity Bluetooth Motorization with Quietude™ Technology	15
7.4V Rechargeable Powertouch	16
12V Non-Rechargeable Simplicity	18
7.4V Rechargeable Simplicity	20
Friction Fit Mounting System	24
12V Simplicity Low Voltage Hardwiring	25
Simplicity Smart Controller	26
 GENERAL INFORMATION	
UV Protection	28
Vane Opening & Closure	28
Measuring	29
Mounting	29
Cleaning & Care	29
Child Safety	30



Midwest
Designer
Supply

1-888-523-2611

**Midwest Designer Supply, Inc.
N30W22377 Green Road Ste C
Waukesha, WI 53186
(262) 523-2600
Fax (262) 524-1007
www.midwestdesignersupply.com**

MDS - your one source for window fashions.